

## MINI-GRINDER OWNER'S INSTRUCTION MANUAL

Original instructions provided by Arbortech Industries



**Thank you for purchasing an Arbortech Product.**

Your Arbortech Mini Grinder has been designed & manufactured to provide you with the highest satisfaction in performance, durability and safe operation.



Double  
Insulated

**FOR SAFETY READ THE MANUAL  
BEFORE USING THIS TOOL**

**Please read this manual carefully to ensure your safety and correct operation and care of the machine.** If you are using the Power Chisel correctly, it will provide you with years of reliable service and save you time and money.

Page No.

## TABLE OF CONTENTS

- 2. Rules for safe operation of electrical equipment
- 5. Knowing your tool
- 6. Unpacking and Assembly
- 7. Operation
- 11. Maintenance
- 13. Accessories & Spare Parts
- 13. Other Products

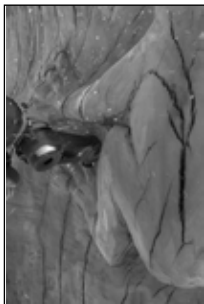

### **WARNING - READ ALL INSTRUCTIONS**

Failure to follow all instructions listed below, may result in electric shock, fire and/or personal injury. The term “power tool” in all the warnings listed below refers to your mains operated (corded) power tool or battery-operated (cordless) power tool.



### GENERAL POWER TOOL SAFETY WARNINGS

#### **WARNING - READ ALL SAFETY WARNINGS AND ALL INSTRUCTIONS**

Failure to follow all instructions listed below, may result in electric shock, fire and/or personal injury.

#### **SAVE ALL WARNINGS AND INSTRUCTIONS FOR FUTURE REFERENCE.**

The term “power tool” in the warnings refers to your mains-operated (corded) power tool or battery-operated (cordless) power tool.

The Arbortech Mini Grinder is designed and built to meet and exceed Australian and International Safety Standards.

Use only Arbortech approved or other qualified service centres for the servicing and/or repair of this tool. For further assistance contact Arbortech.

The Arbortech Mini Grinder is double insulated to provide the highest possible operator protection from electric shock. Please observe all necessary safety precautions to avoid electric shock. Do not operate this tool until you have read and understood all safety instructions and rules of operation. Failure to comply with these instructions can result in serious accidents including fire, electric shock or serious personal injury.

#### 1) **WORK AREA SAFETY**

- **Keep work area well ventilated, clean and well lit.** Cluttered or dark areas invite accidents.
- **Do not operate power tools in explosive atmospheres, such as in the presence of flammable liquids, gases or dust.** Power tools create sparks which may ignite the dust or fumes.
- **Keep children and bystanders away while operating a power tool.** Distractions can cause you to lose control.

## 2) ELECTRICAL SAFETY

- **Power tool plugs must match the outlet. Never modify the plug in any way.**

**Do not use any adapter plugs with earthed (grounded) power tools.** Unmodified plugs and matching outlets will reduce risk of electric shock.

- **Avoid body contact with earthed or grounded surfaces, such as pipes, radiators, ranges and refrigerators.** There is an increased risk of electric shock if your body is earthed or grounded.

- **Do not expose power tools to rain or wet conditions.** Water entering a power tool will increase the risk of electric shock.

- **Do not abuse the cord. Never use the cord for carrying, pulling, or unplugging the power tool. Keep cord away from heat, oil, sharp edges or moving parts.** Damaged or entangled cords increase the risk of electric shock.

- **When operating a power tool outdoors, use an extension cord suitable for outdoor use.** Use of a cord suitable for outdoor use reduces the risk of electric shock.

- **If operating a power tool in a damp location is unavoidable, use a residual current device (RCD) protected supply.** Use of an RCD reduces the risk of electric shock. Note: The term “Residual Current Device (RCD)” may be replaced by the term “ground fault circuit interrupter (GFCI)” or “earth leakage circuit breaker (ELCB)”

## 3) PERSONAL SAFETY

- **Stay alert, watch what you are doing and use common sense when operating a power tool. Do not use a power tool while you are tired or under the influence of drugs, alcohol or medication.** A moment of inattention while operating power tools may result in serious personal injury.

- **Use personal protective equipment. Always wear eye protection.** Protective equipment such as dust mask, non-skid safety shoes, hard hat or hearing protection used for appropriate conditions will reduce personal injuries.

- **Prevent unintentional starting. Ensure the switch is in the off-position before connecting to a power source and/or battery pack, picking up or carrying the tool.** Carrying power tools with your finger on the switch or energizing power tools that have the switch on invites accidents.

- **Remove any adjusting key or wrench before turning the power tool on.** A wrench or a key left attached to a rotating part of the power tool may result in personal injury.

- **Do not overreach. Keep proper footing and balance at all times.** This enables better control of the power tool in unexpected situations
- **Dress properly. Do not wear loose clothing or jewellery. Keep your hair, clothing and gloves away from moving parts.** Loose clothes, jewellery or long hair can be caught in moving parts.
- **If devices are provided for the connection of dust extraction and collection facilities, ensure these are connected and properly used.** Use of dust collection can reduce dust-related hazards.

#### 4) POWER TOOL USE AND CARE

- **Do not force the power tool. Use the correct tool for your application.**

The correct power tool will do the job better and safer at the rate for which it was designed.

• **Do not use the tool if the switch does not turn it on and off.** Any power tool that cannot be controlled with the switch is dangerous and must be repaired.

• **Disconnect the plug from the power source and/or the battery pack from the power tool before making any adjustments, changing accessories, or storing power tools.** Such preventative safety measures reduce the risk of starting the power tool accidentally.

• **Store idle power tools out of the reach of children and do not allow persons unfamiliar with the power tool or these instructions to operate the power tool.**

Power tools are dangerous in the hands of untrained users.

• **Maintain power tools. Check for misalignment or binding of moving parts, breakage of parts and any other condition that may affect the power tools operation. If damaged, have the power tool repaired before use.** Many accidents are caused by poorly maintained power tools.

• **Keep cutting tools sharp and clean.** Properly maintained cutting tools with sharp edges are less likely to bind and are easier to control.

• **Use the power tool, accessories and tool bits etc. in accordance with these instructions, taking into account the working conditions and the work to be performed.** Use of the power tool for operations different from those intended could result in a hazardous situation.

#### 5) SERVICE

• **Have your power tool serviced by a qualified repair person using only identical replacement parts.** This will ensure that the safety of the power tool is maintained.

## 5 Knowing your tool

### TECHNICAL SPECIFICATIONS:

**Max. Blade diameter:** 50 mm

**Max. RPM:** 18,000 rpm @ extension spindle

**Power:** 5.8A ~ 700 Watt

**Rating:** 230-240V, AC, 50-60Hz  
120V, AC, 60Hz

**Disc Bore Size:** 9.5mm

**Max. cutting depth:** 10 mm

**Weight:** 1.83 Kg

**Overall Length:** 350mm

**Vibration emission:** 1.233 m/s<sup>2</sup>

**Noise emission:** 100.7 dB(A)

**Model:** MIN.FG.300.00 AU | MIN.FG.300.00.20 US |  
MIN.FG.300.00.40 UK | MIN.FG.300.00.20 EU

**AUST. APPROVAL** SGSEA/120903

### CE-Declaration of Conformity:

We declare under our sole responsibility that this product is in conformity with the CE Standards.

Note: text, diagrams and data are correct at time of printing. In the interests of continuous improvement of our products, technical specifications are subject to alteration without prior notice.

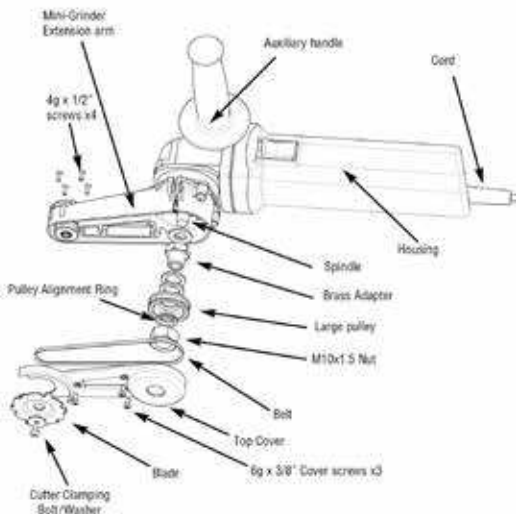

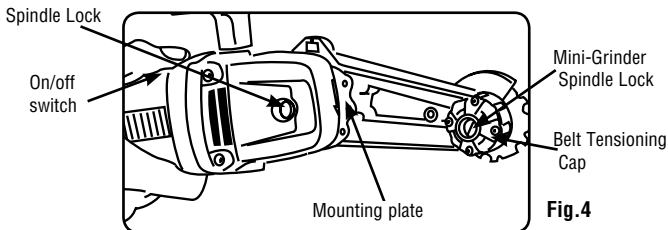

## Unpacking and assembly

1. Remove the Mini Grinder from its box. Inspect to ensure that no damage has occurred during shipping. If damaged, report to the retailer immediately.

2. Remove the auxiliary handle from the box and attach to the tool. (as shown in fig.1)

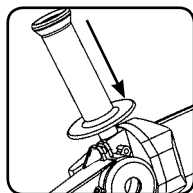

3. Ensure that the Mini Grinder extension arm is always fitted securely to the mounting plate. If loose, tighten the 3 screws that hold the Mini-Grinder to the mounting plate on the tool body. as seen in fig.2.

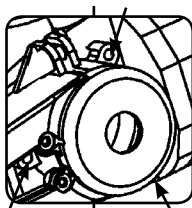

4. The Mini Grinder is packaged with a Mini Grinder Blade fitted, ready for use. Ensure that the **cutter clamping bolt** is tightened fully. (as shown in fig.3)

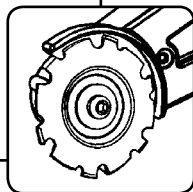

5. Before plugging in, ensure that the on/off switch is in the OFF position.

6. **WARNING: Do not run machine before attaching blade to avoid damage to belt.**

## 7 Operation

### BLADES

- 1 To change blades place a flat head screwdriver into the Mini Grinder spindle lock and hold (seen in fig .5) then unscrew the cutter clamping bolt by using the Allen key provided and remove blade ( as shown in fig 6)
- 2 Place new blade securely on the small pulley. Ensuring that the blade is sitting flat against the pulley.
- 3 Place top washer over blade and secure using the cutter clamping bolt (as shown in fig 6) then tighten

### SANDERS

To replace the blade with sanders follow step 1 to remove blade.

Insert HEXAGONAL BOLT into the mini sander keyway and wind into the mini-grinder spindle in place of the cutter ( as shown in fig 7 ) using the screwdriver for securing.

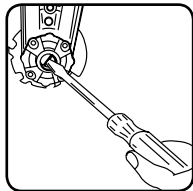

Fig.5

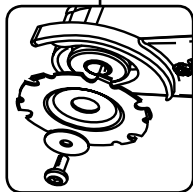

Fig.6

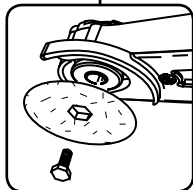

Fig.7



## 8 Operation (cont'd)

### DIAMOND BLADE & MINI INDUSTRIAL BLADE

#### Required Stepwasher

To change blades with Diamond or Mini Industrial Blade follow step 1 as for BLADES on OPERATION ( page 7 ) to remove blade (seen in fig .5) then unscrew the cutter clamping bolt by using the Allen key provided and remove blade (as shown in fig 6)

Fitting Instruction as below

(These instructions are identical for fitting the diamond blade)

There is a brass seating washer loosely fixed to the underside of this cutter. It positions the cutter forward to prevent collision with the inside face of the guard. Please ensure it is fitted on the correct side of the cutter as shown in the diagram.

( as shown in fig 10)

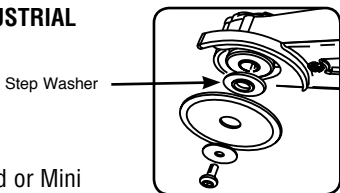

Fig.8

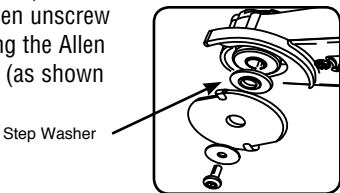

Fig.9

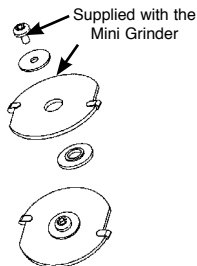

Fig.10

## Operation (cont'd) 9

⚠ **Warning:** Always wear correct safety clothing, including ear, eye and lung protection.

- The Mini Grinder should always be used with two hands, placing the left hand on the auxiliary handle and the right on the tool body. (as shown in fig.11)

### CUTTING GRIP

Fig.11

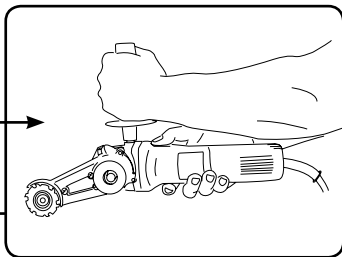

- Ensure the machine is running BEFORE contacting the material, to be worked on.

- To sand, polish or scrub, hold the Mini-Grinder horizontally. (as shown in fig.12).

Fig.12

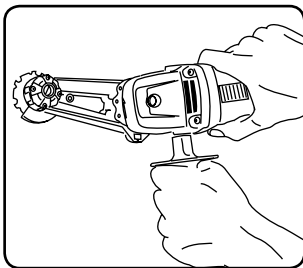

- Use the Mini Grinder Blade to cut or remove wood and plastics. The Mini Sanding Pads are for cleaning and sanding wood, plastics, metal, paint and much more. Use the diamond blade for cutting and recessing any masonry based material.

To trench cut, hold the Mini-Grinder vertically and simultaneously lower into the wood and pull towards you. (as shown in fig.13)

### SHOWING ANGLE & DIRECTION OF CUT

25-30° is a comfortable working angle.

Fig.13

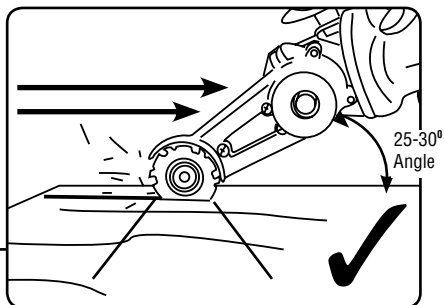

- Use the bottom edge of the blade (as shown in fig.13) And **not** as in fig.14.

Fig.14

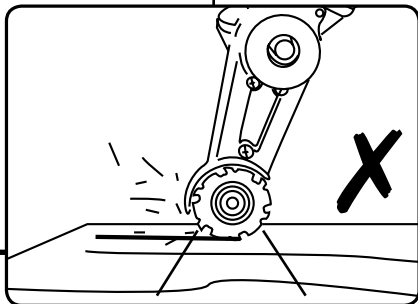

### • Blade sharpening - Mini Grinder Blade:

1. Unplug the Mini Grinder.
2. Use a (5/32") or 4 mm round metal file (MIN. FG.002). When sharpening hold the file at 90° to the blade, keeping the file level. (as shown in fig.15)

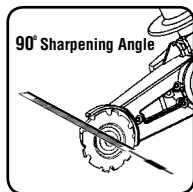

Fig.15

### • Checking adaptor plate

Ensure that the Mini-Grinder adaptor plate is always mounted securely. If loose, tighten the three adaptor plate screws as shown in fig.16.

Note: The arm must be removed to be able to tighten the adapter plate screws to the casting of the grinder

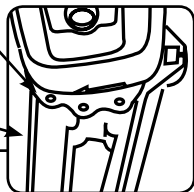

Fig.16

### Cleaning the grills and switch

Regularly check to see if any dust or foreign matter has entered the grills positioned on the front and back of the motor or under the switch (as shown in fig.17). If so use a soft brush to remove any accumulated dust to clean grills and switch.

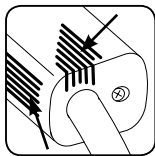
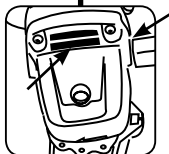

Fig.17



**WARNING**

**ALWAYS USE EYE PROTECTION**

**ALWAYS UNPLUG FROM THE WALL WHEN CLEANING**

### Tensioning or replacing the belt

- Unplug the Mini-grinder
- Remove the 4 belt tensioning cap screws (shown in fig. 18).
- To remove top cover , remove the 3 cover screws (see knowing your tool page 5) then slide cover back away from blade and lift off.
- Rotate tensioning cap Fig 18 to remove slack from the belt fig 19. The blade can be seen moving slightly when rotating the Belt tensioning cap.
- When tensioned secure with top cover screws.

### **DO NOT OVER TENSION THE BELT**

If replacing the belt ensure that the “V” shape sides of the belt are on the inside (as shown in fig.20). Replacement belts (MIN.FG.003) are available through Arbortech Pty Ltd

(see address on back).

Note: clean surroundings with a soft cloth or small brush.

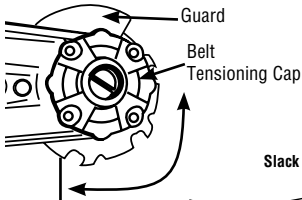

Fig.18

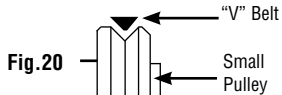

Fig.20

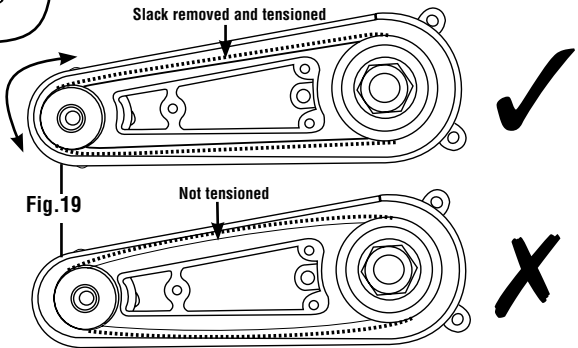

Fig.19

### Accessories & Spare Parts

#### Accessories Available for the Mini-Grinder

MIN.FG.001 Mini-Woodcarver Blades x 2

MIN.FG.002 4mm Sharpening File

MIN.FG.003 Replacement Pulley Belt

MIN.FG.004 Bearing & Spindle Assembly

MIN.FG.006 Mini-Sanders 4x assorted sanders

MIN.FG.008 4 x 40 Grit Mini-Sanders

MIN.FG.009 4 x 60 Grit Mini-Sanders

MIN.FG.010 4 x 80 Grit Mini-Sanders

MIN.FG.011 4 x 120 Grit Mini-Sanders

MIN.FG.012 Mini Industrial Cutter

MIN.FG.016 Mini Diamond Blade

MIN.FG.500 MiniTURBO Blade

Mini Wood  
Carver Blade



Sanding  
Disk

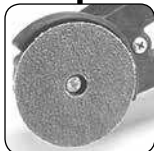

Mini-Industrial  
Blade







Diamond  
Blade





MiniTURBO  
Blade



## 14 Other Products

	Product	Features
	TURBO Plane™	The Arbortech TURBO Plane™ is a universal wood shaping blade that can be used to create different shapes, profiles and finishes. It can be used flat to create large level surfaces, or used at angles to provide shallow cuts for fine shaping, planing and sculpting.
	Mini TURBO™ Kit	The Arbortech Mini TURBO™ Kit is a revolution in wood sculpting. It can be used either directly on the Arbortech Mini Grinder™ or fitted to an angle grinder using the supplied extension adapter. This is an ideal tool to be used freehand or with guides and templates for accuracy. Previously impossible cuts and shapes are now possible. This is the perfect kit for medium size sculpting projects from go to finish.
	TURBO Shaft™	The TURBO Shaft™ is designed to complement the Arbortech TURBO range or as a stand alone tool, the TURBOShaft™ provides detailed freehand carving to perfectly combine efficiency and exceptional control.
	Industrial Woodcarver	The Industrial Woodcarver is our best rotary carving blade. It is the smoothest woodcarving blade available, and you will never have to replace the blade due to interchangeable and rotatable tungsten teeth. It is recommended that the blade is always used in conjunction with the Arbortech Pro Guard.

	Product	Features
 <p>The image shows the Arbortech Contour Random Sander, a handheld power tool with a black body and a silver sanding disc. Below the main tool, there are several circular sanding discs of different colors (black, grey, white) and a small black cylindrical component.</p>	<p>Contour Random Sander</p>	<p>The Arbortech Contour Random Sander is a revolutionary tool for sanding deep profiles, contours and detail work. It is designed to be used directly on any standard 100mm (4") or 115mm (4 1/2") angle grinder. Areas that previously could only be sanded by hand can now be finished rapidly. The random orbital sanding action combined with the patented flexible backing pad creates a perfect finish without scars, scratches or blemishes. The sanding discs are attached via a high temperature pressure sensitive adhesive which transfers the sanding action more efficiently and can withstand much higher temperatures than conventional hook and loop.</p>
 <p>The image shows the Power Chisel, a handheld power tool with a grey and black body and a silver chisel bit.</p>	<p>Power Chisel</p>	<p>The Power Chisel is the ultimate woodworker's sidekick. You simply let the motor do the work and guide the chisel in whichever direction you prefer. The Power Chisel does everything that a traditional hammer and chisel will, only easier and faster. The Power Chisel is so safe and easy to use that it is suitable for anyone to use, from kids to the professional woodworker.</p>
 <p>The image shows the Trade Blade, a circular cutting disc with a central hole. The text 'ARBORTECH' and 'TUFF CUT' is visible on the disc.</p>	<p>Trade Blade (Known as TUFF CUT in Europe and USA)</p>	<p>The Trade Blade is the tradesperson and DIY dream. Its resharpenable tungsten carbide teeth promise long life and unrivalled cutting performance. It is designed for straight cuts and carving through the toughest of materials, from dirty wood with embedded nails to aluminium.</p>





# ARBORTECH™

**AS170**  
BRICK & BLOCK SAW

## **NEW POWERFUL HEAVY DUTY MOTOR**

1250 Watt with over 40% more power for improved cutting performance. Dust resistant heavy duty design ensures long motor life even in the toughest working environments.

**AUTO CUT OFF**  
Prevents motor





**VIBRATION REDUCING HANDLE**

Significant vibration reduction to increase user comfort.

**DUST BOOT WITH VACUUM ATTACHMENT**

Efficient dust control for jobs in sensitive environments.

**RESHARPENABLE TUNGSTEN CARBIDE TEETH**

Long lasting, designed specifically for cutting bricks and mortar.

**BRUSHES**  
damage.



\*Manufacturer reserves the right to change specifications without notice.

\*\*Note: Specifications may differ from country to country.

NOTE: Motor may differ from that shown on box depending on specifications required for your country.

**ARBORTECH PTY LTD • 67 WESTCHESTER ROAD • MALAGA • 6090  
PERTH • WESTERN AUSTRALIA  
TEL: 08 9249 1944 • FAX: 08 9249 2936  
U.S.A. -Tollfree: 866-517-7869  
EUROPE: T: +49 2724-288301**

**[www.arbortechtools.com](http://www.arbortechtools.com)  
Facebook: [www.facebook.com/arbortechtools](https://www.facebook.com/arbortechtools)  
Email: [info@arbortechtools.com](mailto:info@arbortechtools.com)**